



SPECIFICATION



CONFIGURATIONS

MONO TRACK, 2 TRACK, 3 TRACK, QUAD TRACK

SIGHTLINES

INTERLOCK 25 MM

GLAZING

MAX. 56 MM, MIN. 36 MM

MAXIMUM SASH DIMENSIONS

WIDTH (L) 4000 MM, HEIGHT (H) 4000 MM

MAXIMUM SASH WEIGHT

400 KG MANUAL, 700 KG MOTORIZED

COLOUR

POWDER COATING RAL FINISH
STANDARD 7016M, 9005M, 9016G
AVAILABLE IN 150+ RAL FINISHES
TEXTURED FINISH AVAILABLE
SPLIT COLOR FOR INTERIOR/EXTERIOR
WOOD EFFECT POWDER COATING
ANODIZED ALUMINIUM

BFRC Rating

kWh/(m².yr)

≥20	A ++
>10 to 20	A +
0 to <10	A
-10 to <0	B
-20 to <-10	C ✓
-30 to <-20	D
-50 to <-30	E

Double glazing





BFRC Rating

kWh/(m².yr)

≥20	A ++
>10 to 20	A +
0 to <10	A ✓
-10 to <0	B
-20 to <-10	C
-30 to <-20	D
-50 to <-30	E

Triple glazing

FEATURES

U value		Double glazing Uw from 1.3 (W/m ² K)	Triple glazing Uw ≥ 0.9 (W/m ² K)
Acoustic insulation		Rw up to 43 dB	
Air permeability		Class 4	
Water tightness		Class 7A* / 9A**	
Wind resistance		Class C3* / C4**	

Double glazing Ug=1.0 / Triple glazing Ug=0.5

Wind resistance:

* Reference test balcony 4.00 x 3.00 m / 2 sashes

**Reference test balcony 4.00 x 3.00 m / 1 sash + 1 fixed light



INTERLOCK HANDLE



SECURITY
HARDWARE

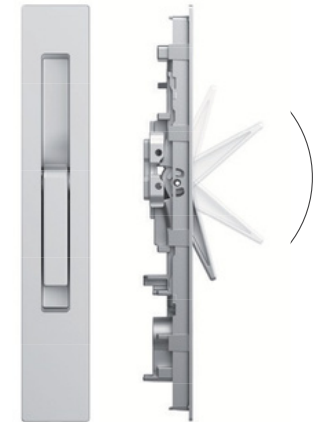

FLUSH SECURITY
HARDWARE

CONFIGURATIONS



2 PANE

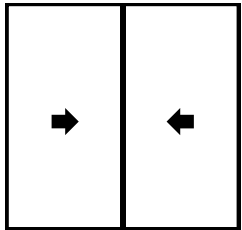

3 PANE

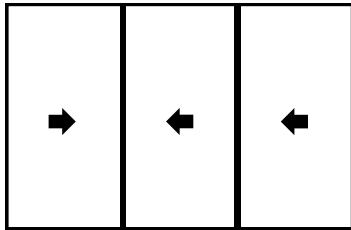

4 PANE

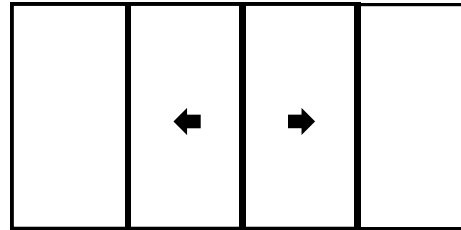

QUAD TRACK

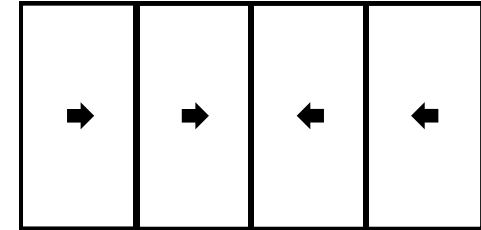

1 PANE POCKET

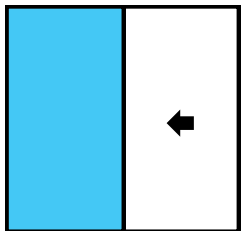

2 PANE POCKET

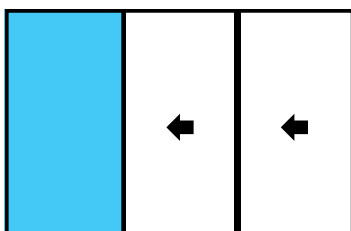

2 PANE POCKET

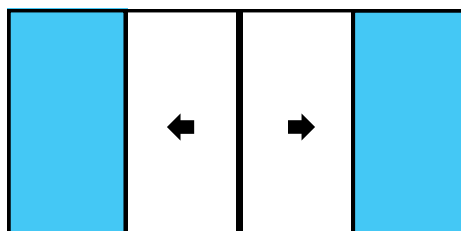

3 PANE POCKET

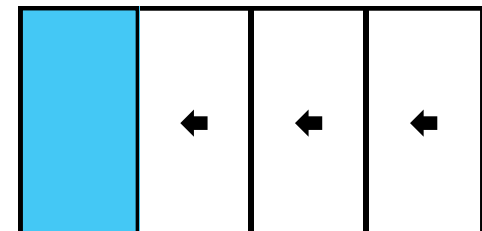

CORNER DOOR
MOVABLE CORNER POST OR
FRAMELESS BONDED CORNER

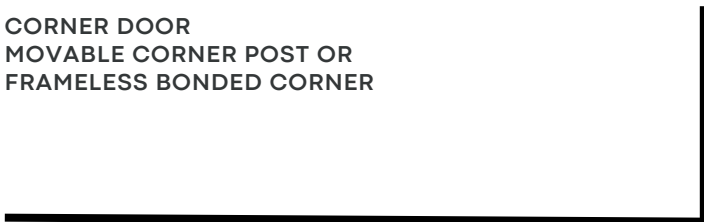

U SHAPE DOOR
MOVABLE CORNER POST OR
FRAMELESS BONDED CORNER

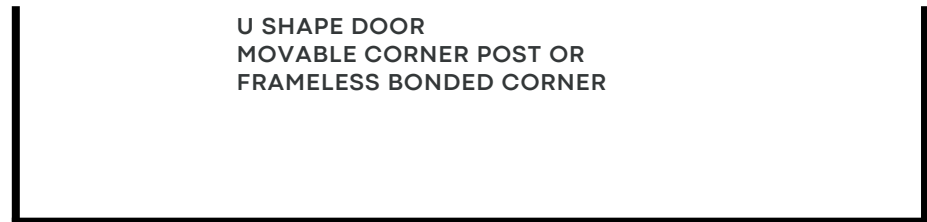

CONFIGURATIONS



HIDDEN TRACK SOLUTION

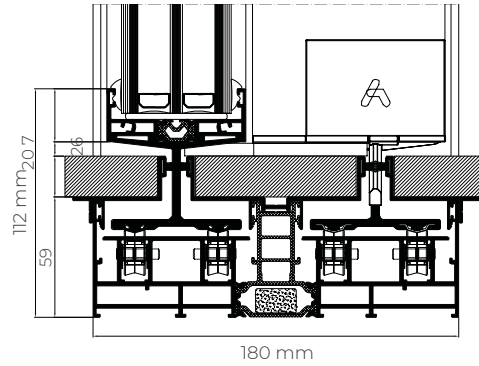

BESPOKE DRAINAGE SOLUTION

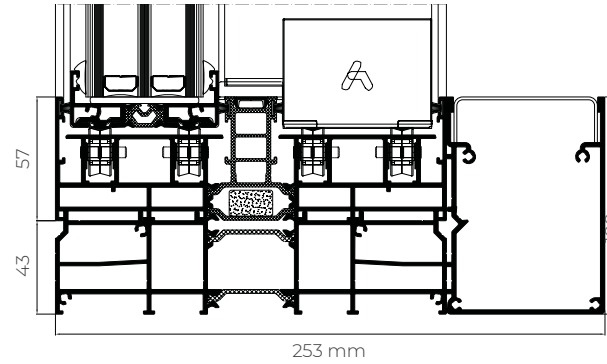

INTERLOCK HANDLE

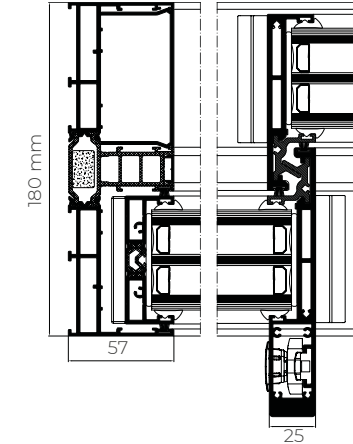

Available with manual (up to 400 kg) or motorized (up to 700 kg) opening system. Additionally, possibility of hiding the rail and even integrating it fully into the floor.

- High thermal & acoustic performance
- Up to 4 by 4 m per panel
- Motorized version
- 25 mm interlock
- Hidden track possibility

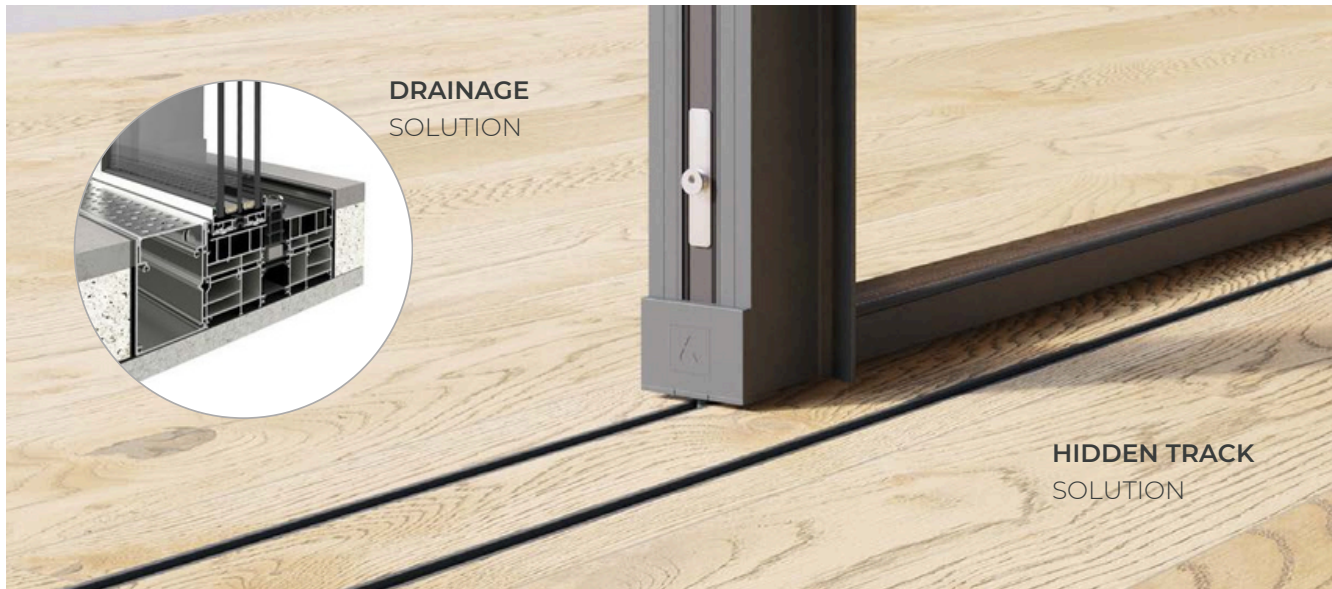

HARDWARE



GREY 7016 **BLACK 9005** **WHITE 9016** **LIGHT SILVER** **DARK SILVER** **CUSTOM RAL**



INTERLOCK HANDLE

Thermally broken minimalist sliding system that provides maximum luminosity with a minimal aluminium interlock profile. It has an elegant design only 20 mm sightline and offers the possibility of an inlaid closing system and of hiding the frame along the perimeter.

Possibility of locking system in the interlock, thus allowing the concealment of the sashes in the frame from a frontal view. Possibility of embedded locking system which facilitates the sashes crossing.



**SECURITY
HARDWARE**

**FLUSH SECURITY
HARDWARE**

